



CDK
EVALUATION KIT FOR
CARBON DIOXIDE DETECTION
INSTRUCTION MANUAL

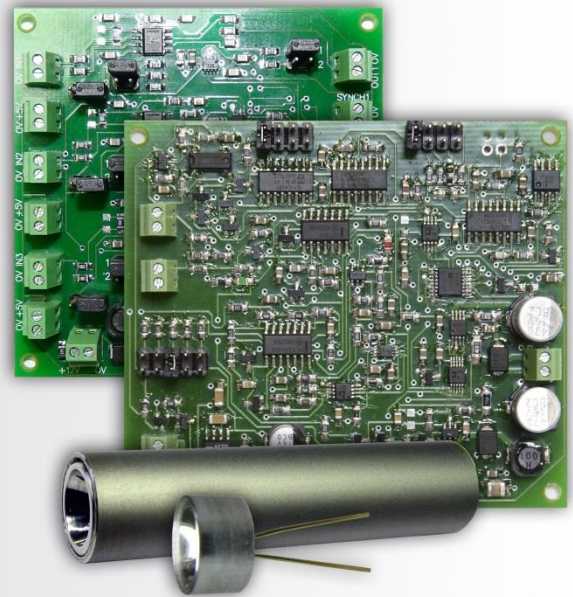

TABLE OF CONTENTS

General Information	3
Application	3
Packaging arrangement	3
Operation conditions	3
Brief overview of the components included	4
Recommended operation mode for the kit	5
Operation instructions	6-8
Precautions	9
Appendices	10
Appendix 1: Lms43LED main parameters	10
Appendix 2: Lms43PD-03 main parameters	11
Appendix 3: Drivers Applicable for the CDK Evaluation Kit	12

GENERAL INFORMATION

Application

CDK is an evaluation kit for CO₂ detection based on mid-infrared LED-PD optopair, which includes all the needed components for quick and simple start. The possibility to change the parts within the kit easily makes the kit a flexible and utility solution.

Packaging arrangement

CDK includes:

- Light-emitting diode Lms43LED-RW
- Photodiode Lms43PD-03-RW with a built-in PD preamplifier
- D-41i/D-51i/mD-1p LED Driver (depends on customer request)
- SDM synchronous detector
- acrylic glass optical chamber (optional)

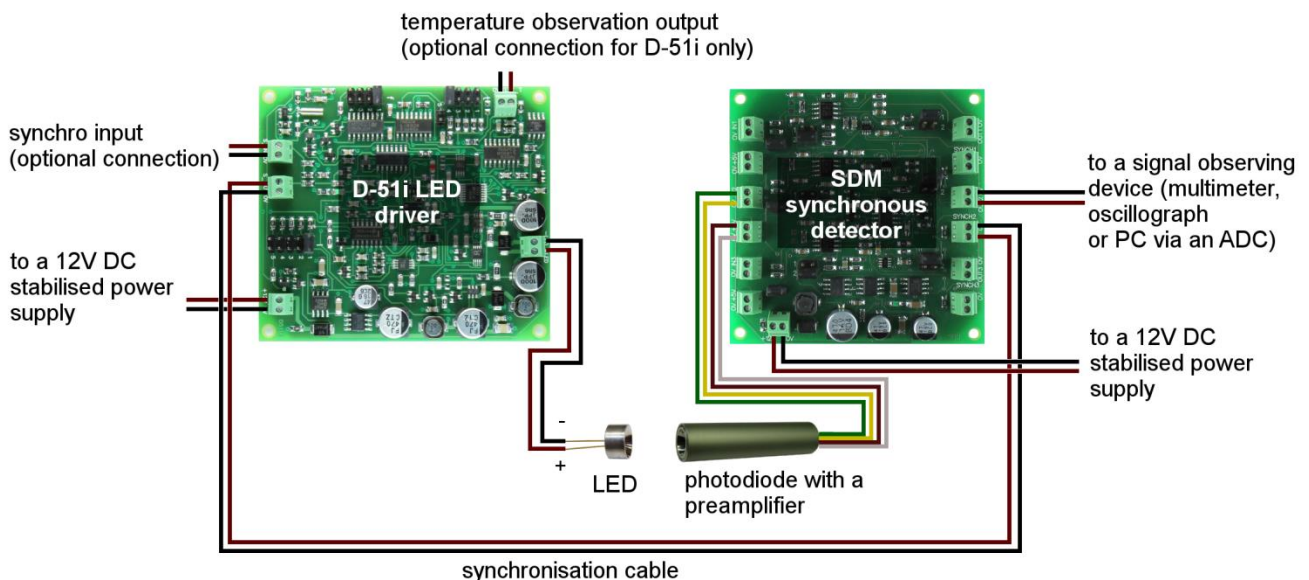

Operation conditions

Indoor operation only. Ingress Protection Rating IP00.

BRIEF OVERVIEW OF THE COMPONENTS INCLUDED

- Light-emitting diode

Light-emitting diode Lms43LED-RW – LMSNT light-emitting diode with 4.3 μm peak wavelength, in TO-18 package with a parabolic reflector. Main LED parameters are pointed in **Appendix 1**. For detailed information and set of characteristics please refer to the appropriate technical passport.

- Photodiode with a built-in preamplifier

Photodiode Lms43PD-03-RW-PA – LMSNT photodiode with 4.6 μm cut-off wavelength, with a built-in preamplifier, mounted in an aluminum tube with a parabolic reflector. PD preamplifier amplifies the current generated by photodiode and converts it into pulse voltage signal. There is straight correspondence between PD current and resulting output voltage, i.e. if the photocurrent from photodiode is a meander, the converted signal will be a meander too with the same frequency and pulse duration.

Main photodiode parameters are pointed in **Appendix 2**. For detailed information and set of characteristics please refer to the appropriate technical passport.

- D-51i/D-41i/mD-1p LED Driver (depends on customer request)

LED Driver is a power supply for an LED. D-41i/D-51i driver types have a set of adjustable parameters to customise the desired operation mode of an LED. mD-1p driver provides operation at one fixed pulse mode (readjusted specially for the system).

For brief information about drivers please refer to **Appendix 3**. For comprehensive information about the driver please refer to the driver's Instruction Manual.

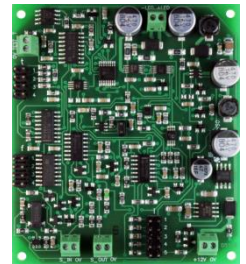

D-51i LED Driver

- SDM Synchronous Detector

SDM synchronous detector measures the voltage signal from the output of photodiode preamplifier and converts it to the DC voltage signal proportional to amplitude of voltage from input.

For comprehensive information about the synchronous detector please refer to the appropriate Instruction Manual.

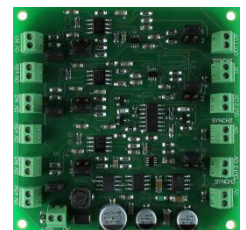

*SDM
Synchronous
Detector*

RECOMMENDED OPERATION MODE FOR THE KIT

Driver settings (for D-41i/D-51i models)		
LED current	I, A	0.6
Pulse duration	τ , μs	150
Frequency	f, kHz	0.5
SDM synchronous detector settings		
Signal gain	times	x5
Averaging time	ms	300

Note! Do not use 2 and 4 kHz driver frequency settings, since they are incompatible with 150 μs pulse duration setting.

OPERATION INSTRUCTIONS

1. Connect the preamplifier output with an input of SDM synchronous detector.

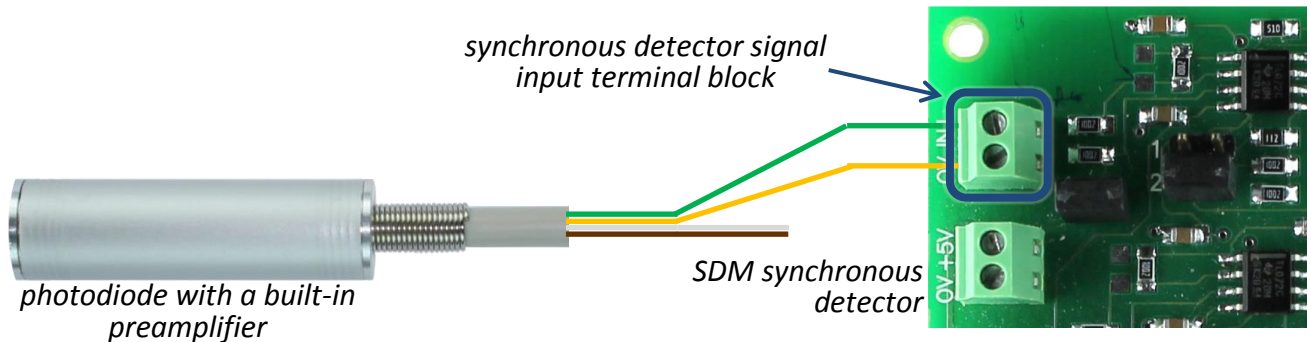

Green cord – to the signal input “+”; Yellow cord – to the signal input “0”

2. Connect a 5V power output of the SDM synchronous detector to the preamplifier power input.

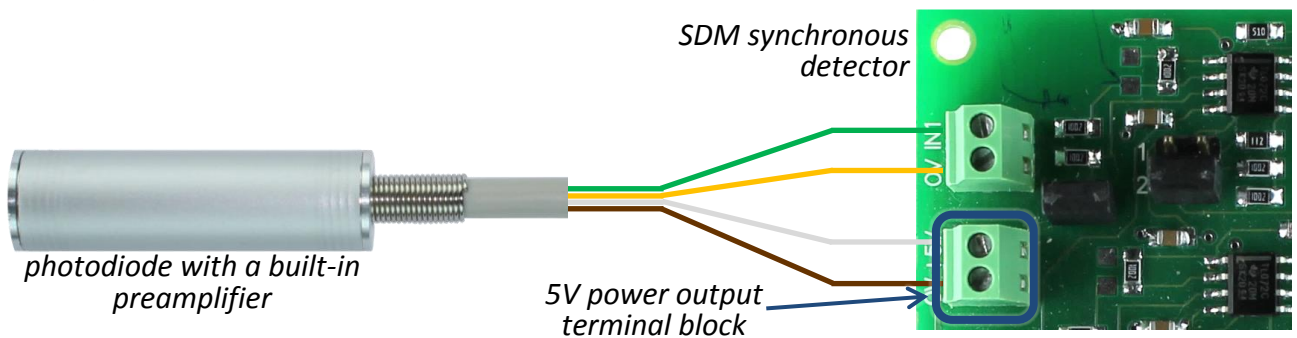

White cord – to the power output “+”; Brown cord – to the power output “0”

Note!

- Please check your connection circuit before turning the PD on.
- Please do not connect the PD to the multimeter.
- Please do not touch the glass covering
- Pay your attention to the colours of the cords; actual colours may differ from ones pointed in the present manual, follow the instructions pointed in the technical data provided with the order.

3. Select the needed signal gain and averaging time on the SDM synchronous detector.

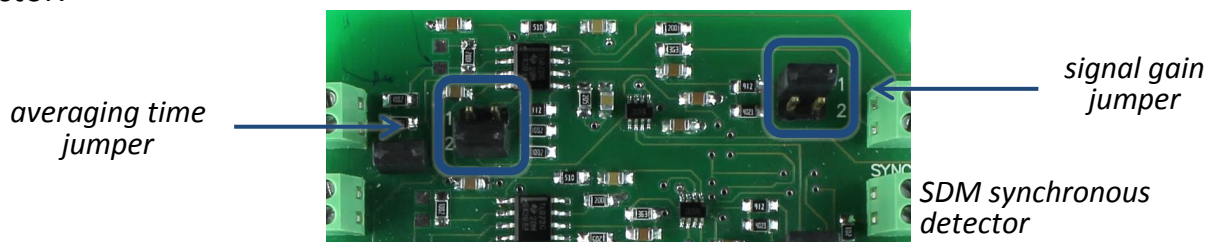

Note! You can find out more about adjustment of the signal gain and averaging time in the appropriate SDM synchronous detector manual.

OPERATION INSTRUCTIONS

4. Connect the LED pins to the LED connection terminal block of the LED driver.

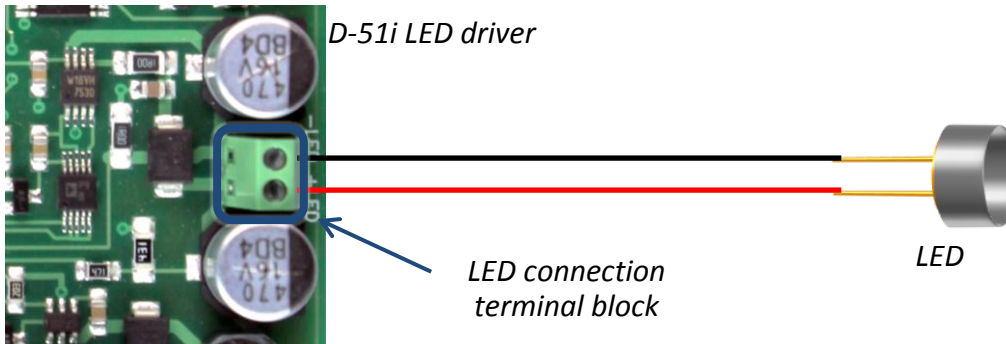

Note! All driver connections in this manual are pointed for D-51i LED driver, connections with other drivers should be done similarly.

CAUTION! The pin with red dot must be connected to the “+” sign of the driver terminal block.

5. Connect the synchronisation output of the LED driver with the synchronisation input of the synchronous detector via synchronisation cable.

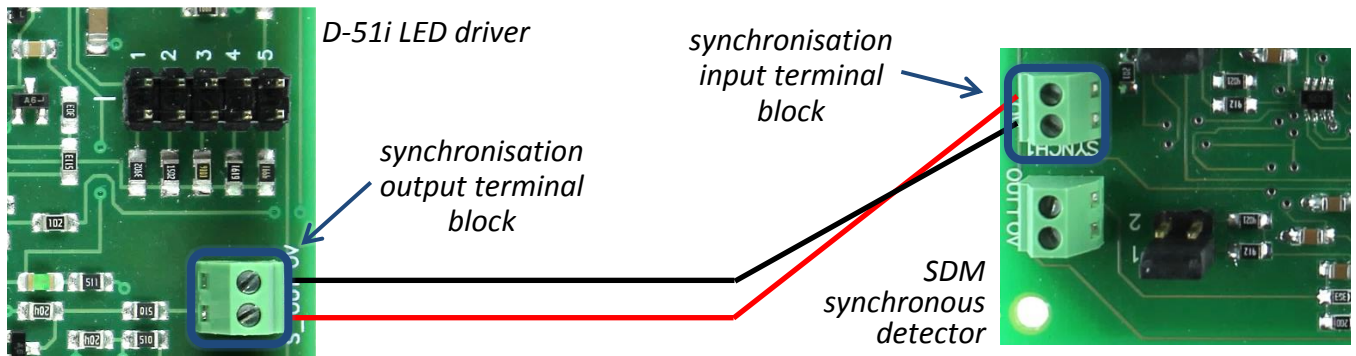

6. Select the needed mode of the LED driver.

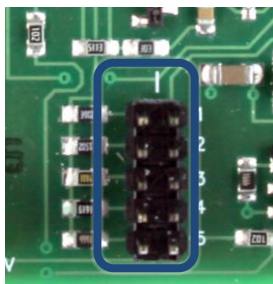

current adjustment jumper

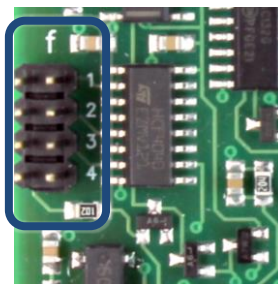

frequency adjustment jumper

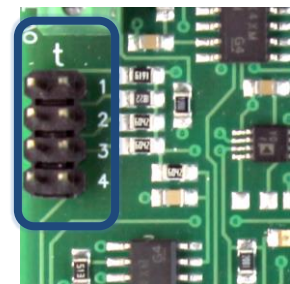

pulse duration adjustment jumper

Note! You can find out more about driver modes and their adjustment in the appropriate Driver Instruction Manual.

OPERATION INSTRUCTIONS

- Connect signal output terminal block of the SDM synchronous detector with signal observing device (multimeter, oscillograph or PC via ADC).

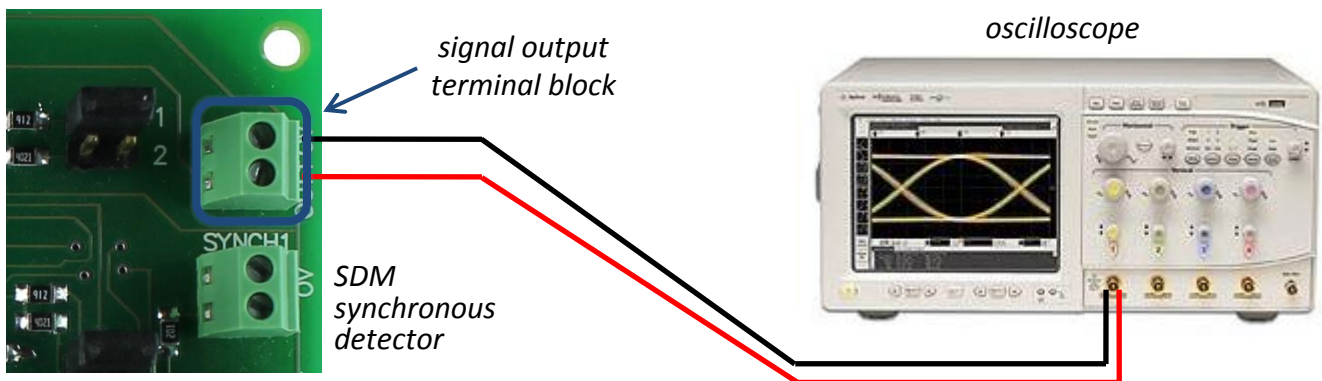

- Connect a 12V DC stabilized power supply to the LED driver and SDM synchronous detector (red wire to the "+"; black wire to the "-").

PRECAUTIONS & NOTES

- ⚠ Turn on the power supply of the LED Driver and SDM synchronous detector only after all connections are made and tested.
- ⚠ Do not switch driver regimes during operation.
- ⚠ Do not use multimeter to control and adjust current of the LED.
- ⚠ Do not bend and/or twist LED and photodiode pins; otherwise the optical system will be damaged.

Note! Please refer to your provider if you have any questions.

Lms43LED Main Parameters (QCW operation mode, f=0.5 kHz, T=300 K)

Parameters	Units	Conditions	Ratings		
			Min	Typ	Max
Peak emission wavelength	μm	T=300 K, I = 150 mA qCW	4,10	4,15	4,30
FWHM of the emission band	nm	I = 150 mA qCW	700	850	1000
Quasi-CW Optical Power	μW	I = 200 mA qCW	8,0	10,0	12,0
Pulsed Peak Optical Power	μW	I=1 A, f=1 kHz, duty cycle 0.1%	180	200	220
Voltage	V	T=300 K, I=200 mA	0,2	-	0,8

Spectra at different currents (qCW, T=300 K)

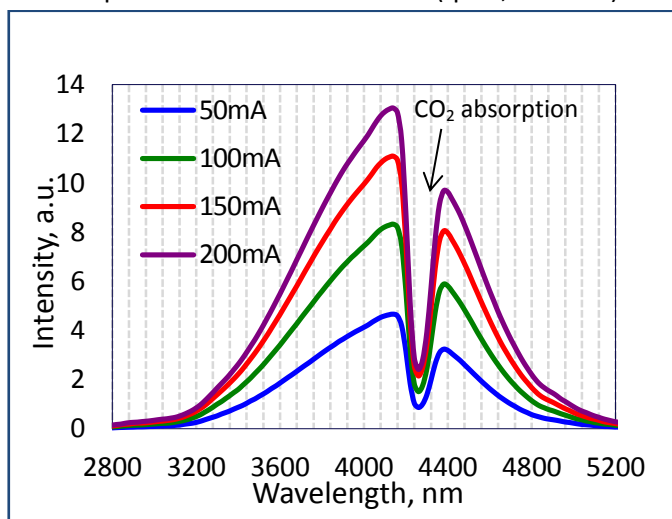

Spectra at different temperatures (qCW, I=150 mA)

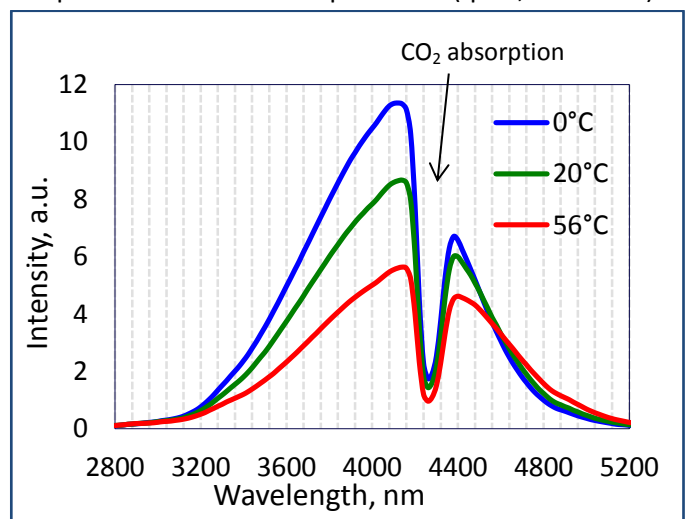

LED Typical Current-Voltage Characteristics (T=300K)

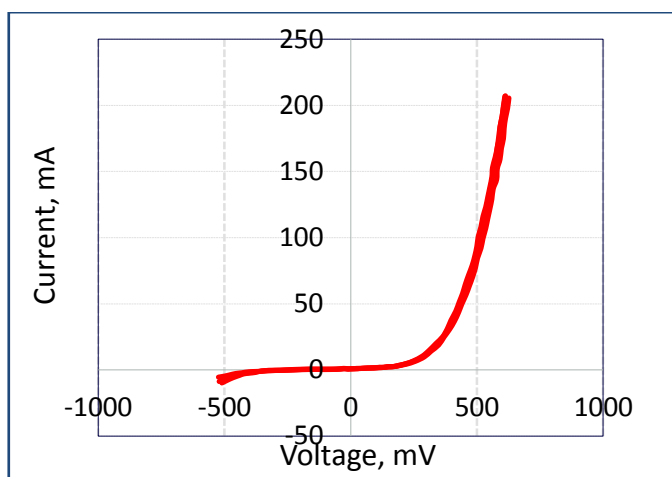

LED Power Characteristic (quasi-CW mode, T=300K)

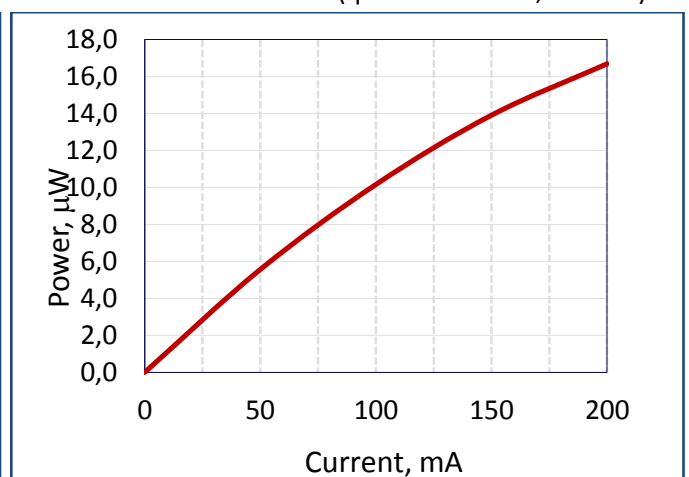

Lms43PD-03 Main Parameters (T=300 K)

Photodiode Parameters	Conditions	Symbol	Value	Units
Cut-off wavelength	T=300 K	λ_{cut}	4.8	mm
Max. sensitivity wavelength (>90%)	T=300 K	λ_p	3.6 — 4.1	mm
Dark current	T=300 K, $V_r=-0,1$ V	I_d	4.0 — 10	mA
Shunt resistance	T=300 K, $V_r=-10$ mV	R_{sh}	10 — 50	Ω
Capacitance	T=300 K, $\lambda=\lambda_p$	C	1300 — 2600	pF
Sensitivity	T=300 K, $\lambda=\lambda_p$	S	0.8 — 1.2	A/W
Detectivity	T=300 K, $\lambda=\lambda_p$	D^*	$(0.6-2)\times 10^9$	$cm\cdot Hz^{1/2}\cdot W^{-1}$

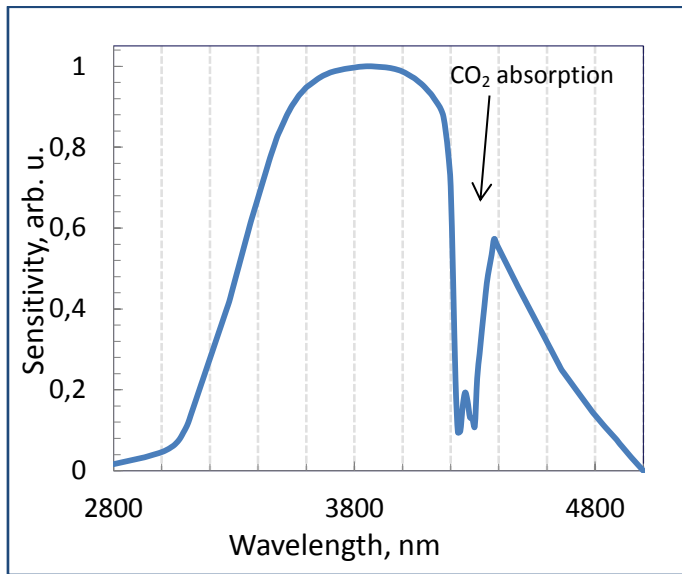

Spectral response (typical)

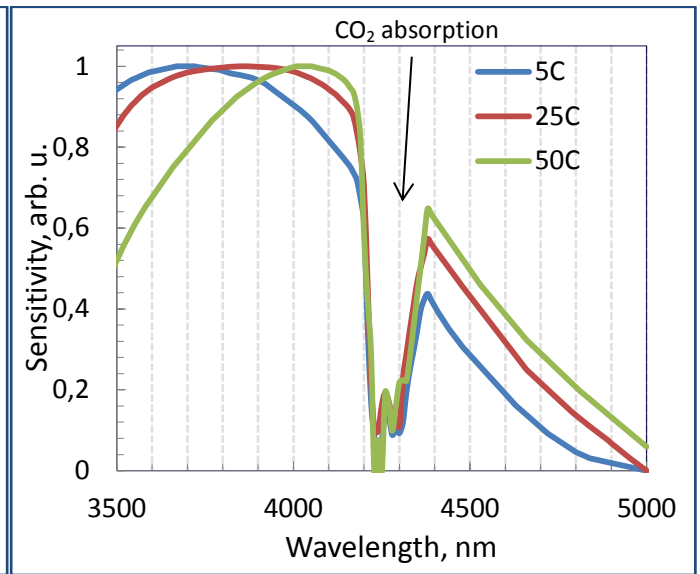

Temperature shift of spectral response

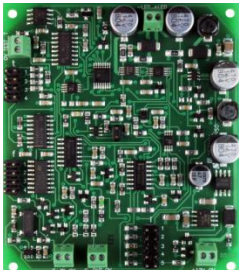

Drivers Applicable for the CDK Evaluation Kit

<p>LED driver D-41i</p> 	<p>D-41i Driver provides Pulse mode operation. Using this mode it is possible to choose one of five current values (0.2/0.6/1/1.5/1.9 A) and select one of four frequencies (0.5/1/2/4 kHz) and choose pulse duration within five values (5/10/20/50/150 μs).</p>
<p>LED driver D-51i</p> 	<p>D-51i Driver has the same characteristics as D-41i but also has another important feature:</p> <p>Temperature control – possibility to define LED p-n junction temperature using current-voltage dependence. Driver generates the low current signal for plugged LED, measures and outputs the voltage. Using the obtained voltage value it is possible to calculate the intrinsic LED temperature.</p>
<p>mD-1p minidriver</p> 	<p>mD-1p minidriver is a cost-effective driver that enables LED operation. It is adjusted especially for the Evaluation Kit for the following mode: 150 mA current, 0.5 kHz frequency and 150 μs pulse duration.</p>